



### FEATURES

- **Compact and lightweight**  
Charged with hydrogen gas for high arc cooling capacity, short gap cutoff has been achieved at high DC voltages.
- **Safety**  
High safety achieved with construction that prevents explosions by keeping the arc from leaking.
- **High contact reliability**  
Since the contact portion is sealed in hydrogen gas, there is no contact oxidation. It is also dustproof and waterproof.

### TYPICAL APPLICATIONS

- High DC voltage applications such as
- **Electric vehicle**
  - **Hybrid vehicle**
  - **Fuel-cell vehicle**
  - **Battery charge and discharge systems**
  - **Construction equipment**

Compliance with RoHS Directive

## ORDERING INFORMATION

AEV   0

#### Contact arrangement

- 1: 1 Form A (Screw terminal, TM, with terminal protection cover)  
5: 1 Form A (TM type)

#### Contact rating

- 1: 10 A  
2: 20 A  
8: 80 A  
9: 300 A  
4: 120 A

#### Coil voltage

- 12: 12V DC  
24: 24V DC

#### Coil terminal structure

- Nil: Plug-in (Faston) (for 20 A type), Connector (for 80 A, 120 A and 300 A)  
2: Plug-in (Faston) (for 10 A type with terminal protection cover)

## TYPES

Type	Nominal coil voltage	Contact arrangement	Part number
10 A	12 V DC	1 Form A	AEV110122
<b>New</b> 20 A			AEV52012
80 A			AEV18012
<b>New</b> 120 A			AEV14012
300 A			AEV19012
10 A	24 V DC	1 Form A	AEV110242
80 A			AEV18024
<b>New</b> 120 A			AEV14024
300 A			AEV19024

Standard packing: Carton: 25pcs. Case: 100pcs (for 10 A type)

Carton: 25pcs. Case: 50pcs (for 20 A type)

Carton: 1pc. Case: 20pcs (for 80 A type)

Carton: 1pc. Case: 20pcs (for 120 A type)

Carton: 1pc. Case: 5pcs (for 300 A type)

## RATING

### 1. Coil data

Type	Nominal coil voltage	Pick-up voltage (at 20°C 68°F)	Drop-out voltage (at 20°C 68°F)	Nominal operating current [±10%] (at 20°C 68°F)	Nominal operating power (at 20°C 68°F)	Max. allowable voltage
10 A	12 V DC	Max. 9 V DC	Min. 1 V DC	0.103 A	1.24 W	16 V DC
20 A		Max. 9 V DC	Min. 0.5 V DC	0.327 A	3.9 W	
80 A		Max. 9 V DC	Min. 1 V DC	0.353 A	4.2 W	
120 A		Max. 9 V DC	Min. 1 V DC	0.353 A	4.2 W	
300 A		Max. 9 V DC	Min. 2 V DC	3.2 A (Inrush)	37.9 W (Inrush, approx. 0.1 sec.) 3.6 W (Stable)	
10 A	24 V DC	Max. 18 V DC	Min. 2 V DC	0.052 A	1.24 W	32 V DC
80 A		Max. 18 V DC	Min. 2 V DC	0.176 A	4.2 W	
120 A		Max. 18 V DC	Min. 2 V DC	0.176 A	4.2 W	
300 A		Max. 18 V DC	Min. 4 V DC	1.85 A (Inrush)	44.4 W (Inrush, approx. 0.1 sec.) 3.8 W (Stable)	

# EV (AEV)

## 2. Specifications

Characteristics	Item	Specifications					
		10A type	20A type	80A type	120 A type	300 A type	
Contact rating	Contact arrangement	1 Form A					
	Nominal switching capacity (resistive load)	10A 400V DC	20A 400V DC	80A 400V DC	120A 400V DC (Carry current)	300A 400V DC	
	Short term current	15A 2min, 30A 30sec (2mm <sup>2</sup> )	40A 10min, 60A 1min (3mm <sup>2</sup> )	120A 15min, 180A 2min (15mm <sup>2</sup> )	225A 3min, 400A 30sec. (38mm <sup>2</sup> )	400A 10 min, 600A 1 min. (100mm <sup>2</sup> )	
	Min. switching capacity (resistive load)* <sup>1</sup>	1A 12V DC	1A 12V DC	1A 12V DC	1A 12V DC	1A 24V DC	
	Max. cut-off current* <sup>5</sup>	—	—	800A 300V DC (Min. 1 cycle)* <sup>2</sup>	1,200A 300V DC (Min. 1 cycle)* <sup>2</sup>	2,500A 300V DC (Min. 3 cycles)* <sup>3</sup>	
	Overload opening/closing rating* <sup>5</sup>	30A 400V DC (Min. 50 cycles)* <sup>2</sup>	60A 400V DC (Min. 50 cycles)* <sup>2</sup>	120A 400V DC (Min. 50 cycles)* <sup>2</sup>	800A 300V DC (Min. 5 cycles)* <sup>2</sup> 120A 400V DC (Min. 50 cycles)* <sup>2</sup>	600A 400V DC (Min. 300 cycles)	
	Reverse direction cut-off* <sup>5</sup>	—	—	-120A 200V DC (Min. 50 cycle)* <sup>2</sup>	-120A 200V DC (Min. 50 cycle)* <sup>2</sup>	-300A 200V DC (Min. 100 cycles)	
	Contact voltage drop (Initial)	Max. 0.5V (By voltage drop 6 V DC 10A)	Max. 0.2V (By voltage drop 6 V DC 20A)	Max. 0.067 V (By voltage drop 6 V DC 20A)	Max. 0.03V (By voltage drop 6 V DC 20A)	Max. 0.06V (300 A Carry current)	
Electrical characteristics	Insulation resistance (Initial)	Min. 100MΩ (at 500 V DC, Measurement at same location as "Initial breakdown voltage" section.)					
	Breakdown voltage (Initial)	Between open contacts	2,500Vrms/min. (Detection current: 10mA)				
		Between contact and coil	2,500Vrms/min. (Detection current: 10mA)				
	Operate time (at 20°C 68°F)	Max. 50ms (Nominal coil voltage applied to the coil, excluding contact bounce time.)				Max. 30ms (Nominal coil voltage applied to the coil, excluding contact bounce time.)	
Release time (at 20°C 68°F)	Max. 30ms (Nominal coil voltage applied to the coil, without diode.)				Max. 10ms (Nominal coil voltage applied to the coil, without diode.)		
Mechanical characteristics	Shock resistance	Functional	Min. 196m/s <sup>2</sup> {20 G} (Half-wave pulse of sine wave: 11ms; detection time: 10μs)	For ON: Min. 196m/s <sup>2</sup> {20 G} (Half-wave pulse of sine wave: 11ms; detection time: 10μs) For OFF: Min. 98m/s <sup>2</sup> {10 G} (Half-wave pulse of sine wave: 11ms; detection time: 10μs)			
		Destructive	Min. 490 m/s <sup>2</sup> {50 G} (Half-wave pulse of sine wave: 6ms)				
	Vibration resistance	Functional	10 to 200 Hz, Min.43 m/s <sup>2</sup> {4.4 G} (Detection time: 10μs)				10 to 200 Hz, Min.44 m/s <sup>2</sup> {4.5 G} (Detection time: 10μs)
		Destructive	10 to 200 Hz, Min.43 m/s <sup>2</sup> {4.4 G} (Time of vibration for each direction; X, Y, Z direction: 4 hours)				10 to 200 Hz, Min.44 m/s <sup>2</sup> {4.5 G} (Time of vibration for each direction; X, Y, Z direction: 4 hours)
Expected life	Mechanical	Min. 10 <sup>5</sup>	Min. 2×10 <sup>5</sup>				
	Electrical (resistive load)	10A 400V DC Min. 75,000* <sup>2</sup>	20A 400V DC Min. 3,000* <sup>2</sup>	80A 400V DC Min. 1,000* <sup>2</sup>	30A 400V DC Min. 3,000* <sup>2</sup>	300A 400V DC Min. 1,000	
Conditions	Conditions for operation, transport and storage	Ambient temperature: -40 to +80°C -40 to +176°F (Storage: Max. 85°C 185°F), Humidity: 5 to 85% R.H. (Not freezing and condensing at low temperature)				Ambient temperature: -40 to +85°C -40 to +185°F (Storage: Max.85°C 185°F), Humidity: 5 to 85% R.H. (Not freezing and condensing at low temperature)	
Mass (Approx.)		90 g 3.17 oz	180 g 6.35 oz	400 g 14.11 oz	400 g 14.11 oz	750 g 26.46 oz	

Notes: \*1. This value can change due to the switching frequency, environmental conditions, and desired reliability level, therefore it is recommended to check this with the actual load.

\*2. The electrical load performance value for the 10A, 20A, 80A and 120 A types applies when a varistor is connected in parallel to the coil. Please be warned that working life will be reduced when a diode is used.

\*3. Condition: Nominal switching 10 cycles, each cut-off 2,500 A

\*4. The coil voltage 12 V DC type and 24 V DC type have the same specifications.

\*5. at L/R ≤ 1ms

**REFERENCE DATA**

1.-(1) Ambient temperature characteristics (10 A type)  
Sample: EV relay 10 A, 3 pcs.

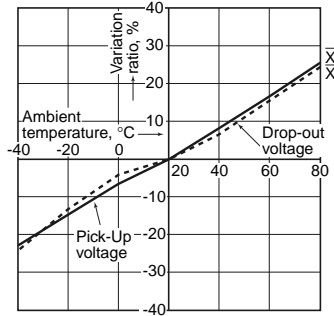

1.-(2) Ambient temperature characteristics (20 A type)  
Sample: EV relay 20 A, 3 pcs.

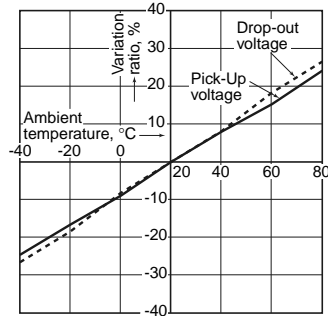

1.-(3) Ambient temperature characteristics (80 A type)  
Sample: EV relay 80 A, 3 pcs.

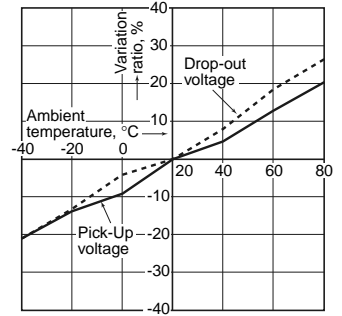

1.-(4) Ambient temperature characteristics (120 A type)  
Sample: EV relay 120 A, 3 pcs.

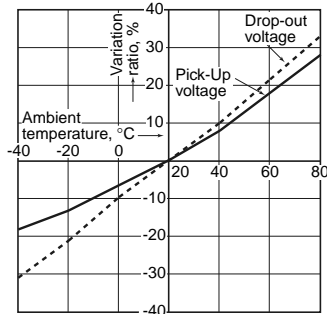

1.-(5) Ambient temperature characteristics (300 A type)  
Sample: EV relay 300 A, 3 pcs.

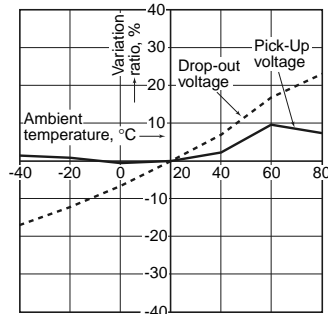

2. Max. value for switching capacity

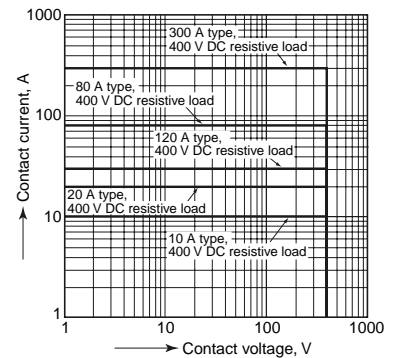

3. Switching life curve

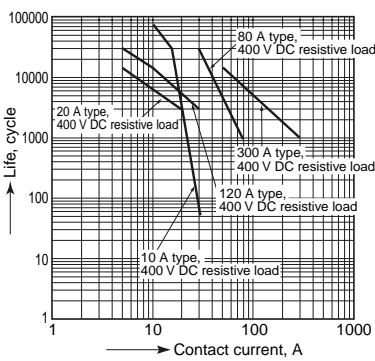

4. Cut-off life curve

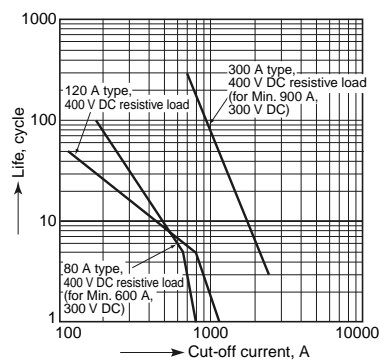

5. Carrying performance curve (80°C 176°F)  
\*For 300 A, at 85°C 185°F

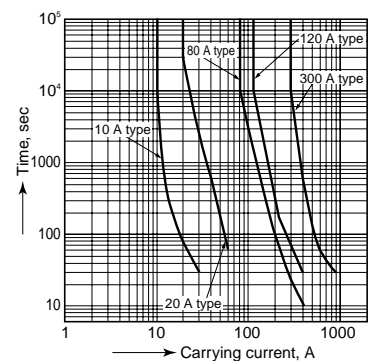

# EV (AEV)

## DIMENSIONS (mm inch)

The CAD data of the products with a **CAD Data** mark can be downloaded from: <http://panasonic-electric-works.net/ac>

### 1. 10 A type

#### CAD Data

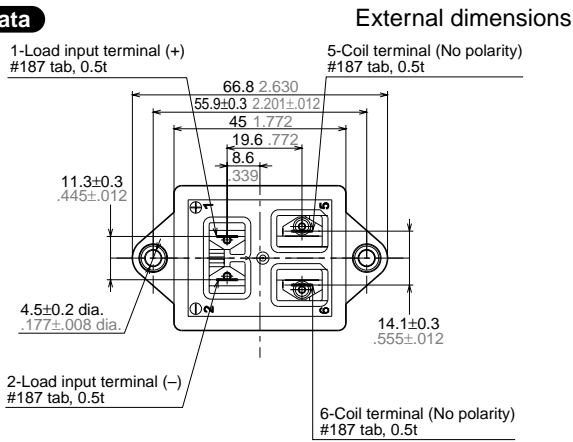

#### Schematic (TOP VIEW)

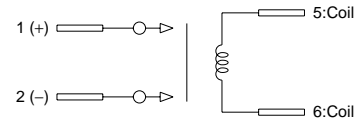

Load side has polarities (+) and (-)

#### Mounting dimensions

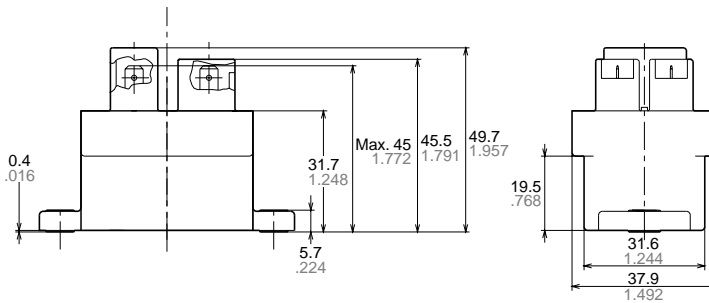
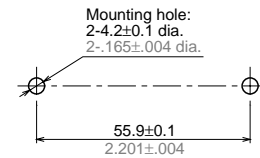

#### General tolerance:

less than 10 .394: ±0.3 ±.012  
10 to 50 .394 to 1.969: ±0.6 ±.024  
more than 50 1.969: ±1.0 ±.039

### 2. 20 A type

#### CAD Data

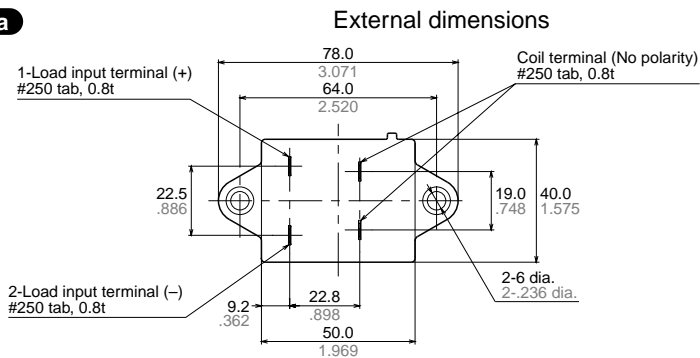

#### Schematic (TOP VIEW)

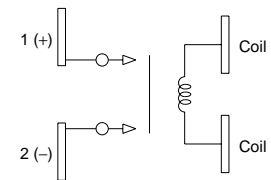

Load side has polarities (+) and (-)

#### Mounting dimensions

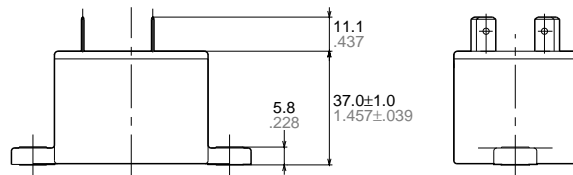
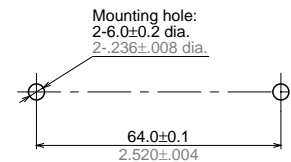

#### General tolerance:

less than 10 .394: ±0.3 ±.012  
10 to 50 .394 to 1.969: ±0.6 ±.024  
more than 50 1.969: ±1.0 ±.039

3. 80 A type

CAD Data

External dimensions

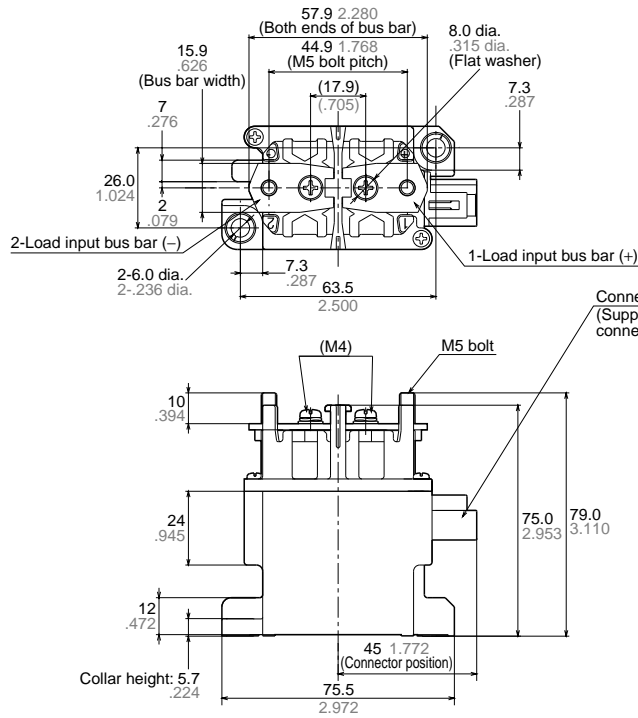

Schematic (TOP VIEW)

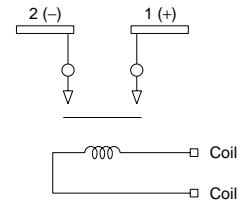

Mounting dimensions

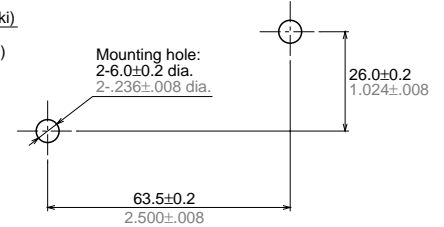

General tolerance:

less than 10 .394: ±0.3 ±.012  
10 to 50 .394 to 1.969: ±0.6 ±.024  
more than 50 1.969: ±1.0 ±.039

\*Note: Separate connection of the terminal and lead wire is required.

4. 120 A type

CAD Data

External dimensions

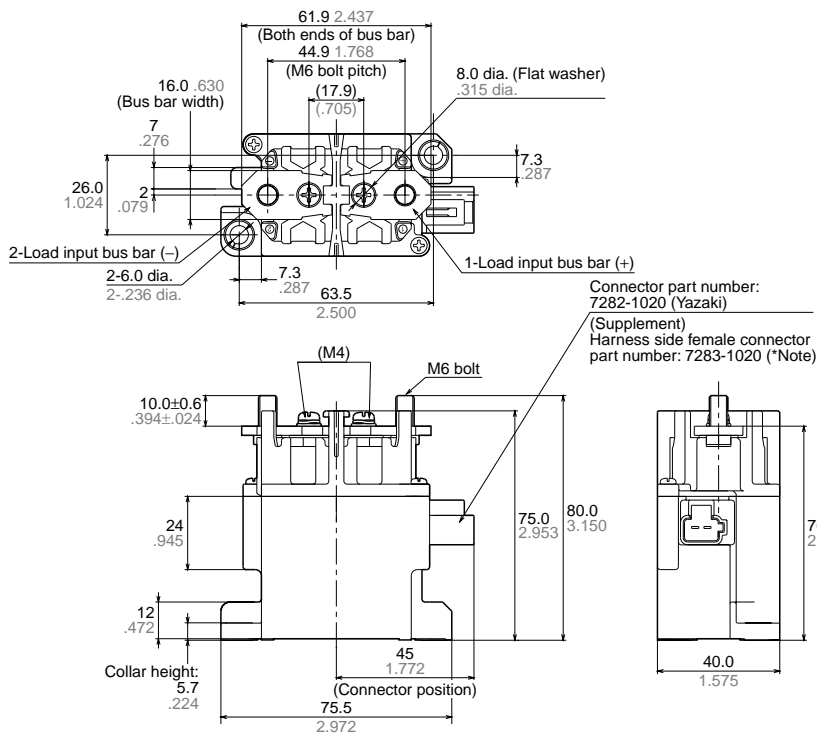

Schematic (TOP VIEW)

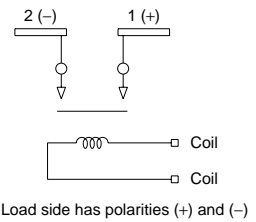

Mounting dimensions

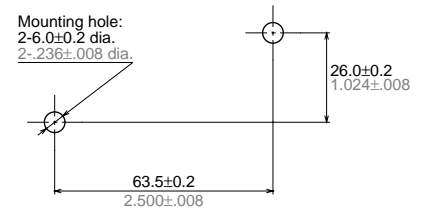

General tolerance:

less than 10 .394: ±0.3 ±.012  
10 to 50 .394 to 1.969: ±0.6 ±.024  
more than 50 1.969: ±1.0 ±.039

\*Note: Separate connection of the terminal and lead wire is required.

# EV (AEV)

## 5. 300 A type

### CAD Data

#### External dimensions

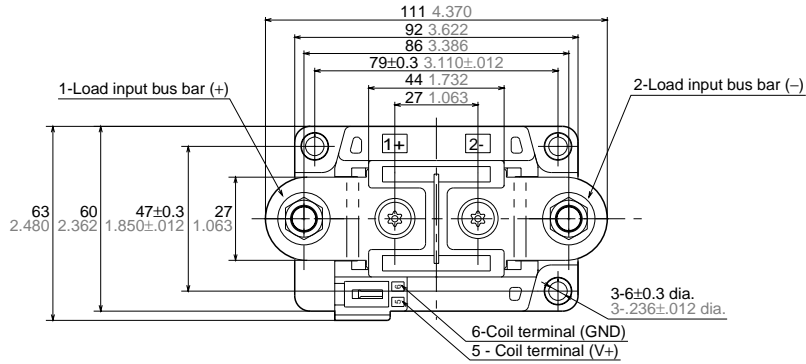

Connector part number: 7282-1020 (Yazaki)  
 (Supplement) Harness side female  
 connector part number: 7283-1020 (\*Note)

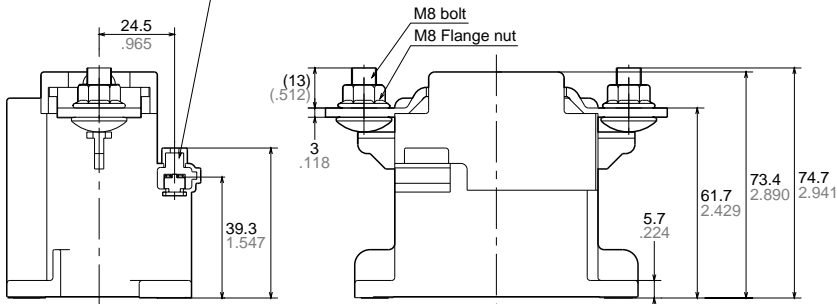

#### Schematic (TOP VIEW)

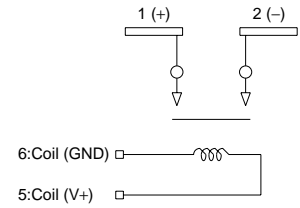

Load side has polarities (+) and (-)

#### Mounting dimensions

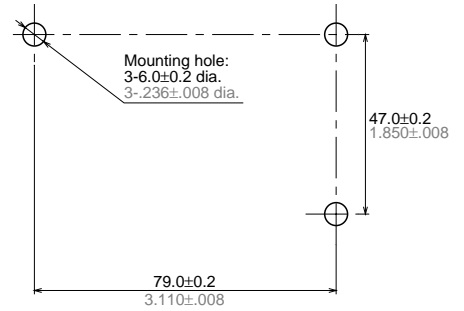

#### General tolerance:

less than 10 .394:  $\pm 0.3 \pm 0.012$   
 10 to 50 .394 to 1.969:  $\pm 0.6 \pm 0.024$   
 more than 50 1.969:  $\pm 1.0 \pm 0.039$   
 more than 100 3.937:  $\pm 1.6 \pm 0.063$

\*Note: Separate connection of the terminal and lead wire is required.

## NOTES

**1. For general cautions for use, please refer to the “CAUTIONS FOR USE OF AUTOMOTIVE RELAYS”.**

**2. When installing the relay, always use washers to prevent the screws from loosening.**

Tighten each screw within the rated range given below. Exceeding the maximum torque may result in breakage. Mounting is possible in either direction.

<Relay installing section>

- M4 screw (for 10A type): 1.8 to 2.7 N·m
- M5 screw (for 20A, 80A, 120A and 300A types): 3 to 4 N·m

<Main terminal installing section>

- M5 nut (for 80A type): 3 to 4 N·m
- M6 nut (for 120A type): 6 to 8 N·m
- M8 nut (for 300A type): 10 to 12 N·m

**3. The coils (300 A type) and contacts (all type) of the relay are polarized, so follow the connection schematic when connecting the coils and contacts.**

Type 300 A contains a reverse surge voltage absorption circuit; therefore a surge protector is not needed. We recommend installing a surge protector varistor (ZNR) for the 10A, 20A, 80A and 120A types.

<Recommend varistor>

Amount of proof energy: Min. 1 J  
Varistor voltage: 1.5 to 2.0 times of nominal voltage

Avoid using a diode as this may result in decreased cut-off capability.

**4. As a general rule, do not use a relay if it has been dropped.**

**5. Avoid mounting the relay in strong magnetic fields (near a transformer or magnet) or close to an object that radiates heat.**

**6. Electrical life**

This relay is a high-voltage direct-current switch. In its final breakdown mode, it may lose the ability to provide the proper cut-off. Therefore, do not exceed the indicated switching capacity and life. (Please treat the relay as a product with limited life and replace it when necessary.)

In the event that the relay loses cut-off ability, there is a possibility that burning may spread to surrounding parts, so configure the layout so that the power is turned off within one second.

**7. Permeation life of internal gas**

This relay uses a hermetically encased contact (capsule contact) with gas inside. The gas has a permeation life that is affected by the temperature inside the capsule contact (ambient temperature + temperature rise due to flow of electrical current). For this reason, make sure the ambient operating temperature is between  $-40$  and  $80^{\circ}\text{C}$   $-40$  and  $+176^{\circ}\text{F}$  (300A type is Max.  $85^{\circ}\text{C}$   $185^{\circ}\text{F}$ ), and the ambient storage temperature is between  $-40$  and  $85^{\circ}\text{C}$   $-40$  and  $+185^{\circ}\text{F}$ .

**8. If the power is turned off and then immediately on after applying the rated voltage (current) continuously to the relay's coil and contact, the resistance of the coil will increase due to a rise in the coil temperature.**

This causes the pick-up voltage to rise, and possibly exceed the rated pick-up voltage. In these circumstances, take measures such as reducing the load current, limiting the duration of current flow, and applying a coil voltage higher than the rated operating voltage.

**9. Main contact ratings in the ratings apply to when there is a resistive load. If you are using an inductive load (L load) such that  $L/R > 1$  ms, add surge protection in parallel with the inductive load. If this is not done, the electrical life will decrease and cut-off failure may occur.**

**10. For the 300 A type, drive the coil with a quick startup. (Built-in one-shot pulse generator circuit)**

**11. Be careful that foreign matter and oils and fats kind don't stick to the main terminal parts because it is likely to cause terminal parts to give off unusual heat.**

**Also, please use the following materials for connected harnesses and bus bars.**

10A type: Min. 2 mm<sup>2</sup> nominal cross-sectional area

20A type: Min. 3 mm<sup>2</sup> nominal cross-sectional area

80A type: Min. 15 mm<sup>2</sup> nominal cross-sectional area

120A type: Min. 38 mm<sup>2</sup> nominal cross-sectional area

300A type: Min. 100 mm<sup>2</sup> nominal cross-sectional area

**12. As a guide, the insertion strength of the plug-in terminal into the relay tab terminal should be 40 to 70N (10A type), 40 to 80N (20A type). Please select a plug-in terminal (flat connection terminal) which comply with JIS C2809-1992.**

10A type: for plate thickness 0.5mm and #187 tab terminal

20A type: for plate thickness 0.8mm and #250 tab terminal

**13. Avoid excessive load applied to the terminal in case of installing such as a bus bar etc., Because it might adversely affect the opening and closing performance.**

**14. Use the specified connector for the connector terminal connection (80A, 120A and 300A) Yazaki Corporation 7283 – 1020 or equivalent**

**15. After the ON signal enters the 300A type, automatic coil current switching occurs after approximately 0.1 seconds. Do not repeatedly turn it OFF within that 0.1 seconds interval, as doing so may damage the relay.**

**For Cautions for Use, see Relay Technical Information.**