

## ISA-PLAN® - SMD Präzisionswiderstände / SMD precision resistors

TECHNISCHE DATEN / TECHNICAL DATA		
Widerstandswerte	Resistance values	1mOhm - 500 mOhm
Toleranz	Tolerance	1 %, 5 %
Temperaturkoeffizient(MANGANIN®)	Temperature coefficient (tcr)	< 50 ppm/K ( 20 °C to 60 °C )
Temperaturbereich	Applicable temperature range	-55 °C to +170 °C
Belastbarkeit	Load capacity	1 W
Innerer Widerstand ( $R_{thi}$ )	Internal heat resistance ( $R_{thi}$ )	< 30 K/W
Isolationsspannung	Dielectric withstanding voltage	100 V
Induktivität ( $R < 25$ mOhm)	Inductance ( $R < 25$ mOhm)	< 3 nH
Stabilität (Nennlast) Abweichung $T_K =$ Kontaktstellentemperatur Stability (nominal load) deviation $T_K =$ Terminal temperature		< 1.0 % nach/after 2000 h ( $T_K = 105$ °C) < 2.0 % nach/after 2000 h ( $T_K = 140$ °C)

### MERKMALE / FEATURES

- 1 Watt Dauerleistung
- 1 Watt permanent power
- Dauerströme bis 30 A ( 1 mOhm )
- Continuous current load up to 30 Amps ( 1 mOhm )
- Standard-Lötpadgeometrie (Baugröße 2010)
- Standard pad size (size 2010)
- Sehr hohe Pulsbelastbarkeit
- High pulse power rating
- Bauteilemontage: Reflow-, und IR-Löten kein Wellenlöten
- Mounting: reflow-, and infrared soldering no wave soldering

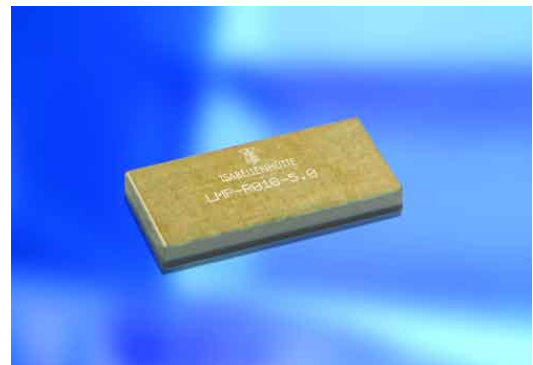

Bauform/Size 2010

### APPLIKATIONEN / APPLICATION

- Messwiderstand für Leistungshybride
- Current sensor for power hybrid applications
- Steuergeräte in der Automobiltechnik
- Control systems for the automotive market
- Leistungsmodulare
- Power modules
- Schaltnetzteile
- Switch mode power supplies

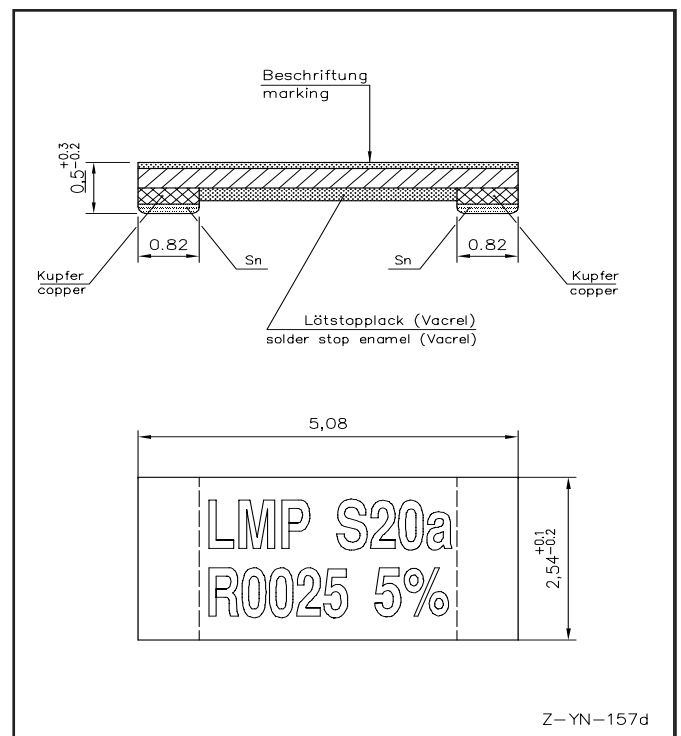

TK und Lastminderung / TCR and power derating

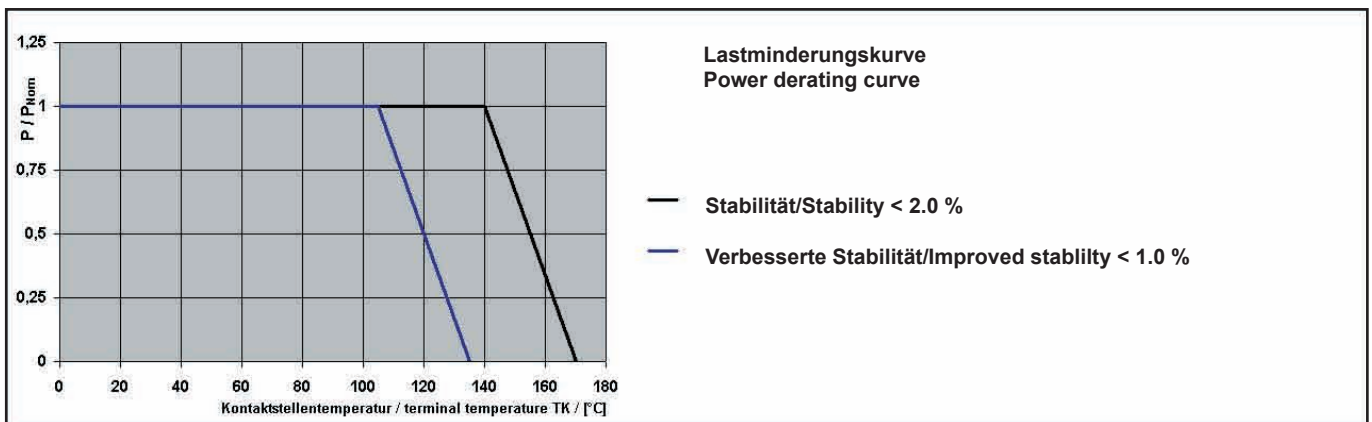
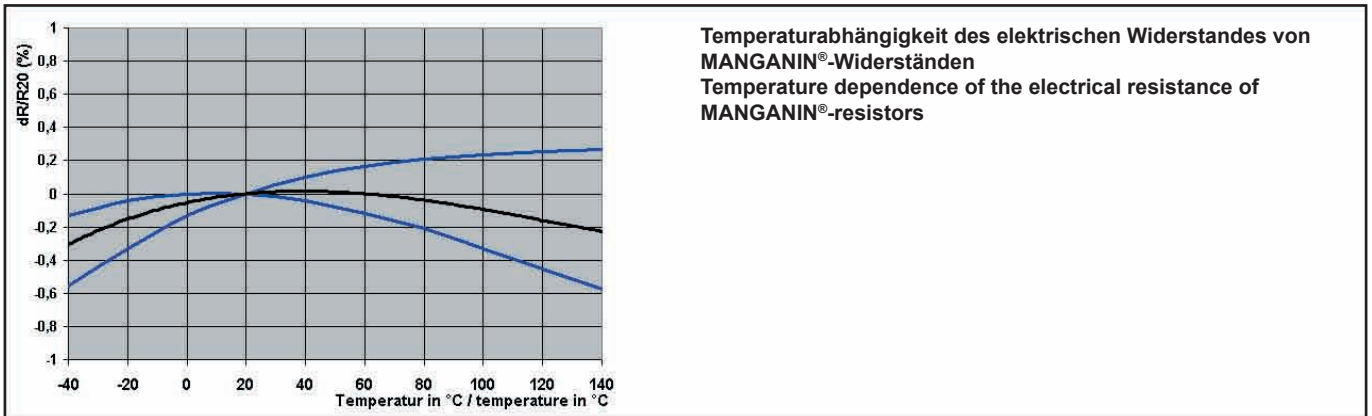

**Vorschlag für Leiterplatten Layout (Reflowlöten)**  
**Proposal for pcb-layout (reflow soldering)**

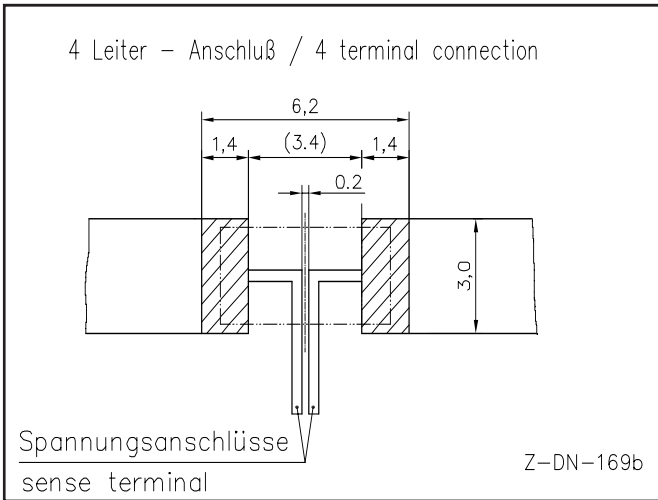

Bei abweichender Lötpadgeometrie kann es zu gemessenen R- Wert Verschiebungen kommen.

With differing pcb-layout geometry it is possible that the measured resistance value can be changed.

Lötprofil Vorschlag / Recommended solder profile			
Reflow-, IR-löten			
Reflow, infrared soldering			
Temperatur	260 °C	255 °C	217 °C
Zeit (s)	peak	40	90
<p>RoHS 2002/95/EG konform seit Produktstart</p> <p>Ausführliche Informationen erhalten Sie auf unserer Homepage:  <a href="http://www.isabellenhuette.de">www.isabellenhuette.de</a></p> <p>RoHS 2002/95/EC compliance since product launch.</p> <p>For more information please visit our website:  <a href="http://www.isabellenhuette.de">www.isabellenhuette.de</a></p>			

GURTINFORMATIONEN TAPE & REEL INFORMATION	
Norm / Specification	DIN EN 60286-3
Gurtbreite / Tape width	12 mm
Anzahl Bauteile/Parts per reel	10000

BESTELLBEZEICHNUNG / ORDERING CODE		
LMP-R001-1.0		
Typ	Widerstandswert	Toleranz
Type	Resistance value	Tolerance
LMP	1 mOhm	1.0 %

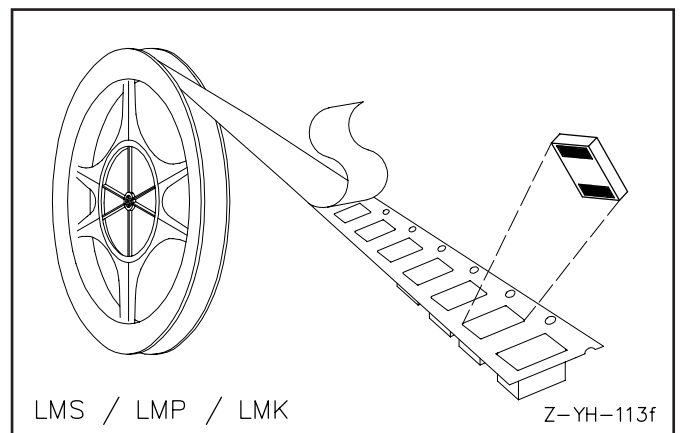

**Gewährleistung**

Alle Angaben über Eignung, Verarbeitung und Anwendung unserer Produkte, technische Beratung und sonstige Angaben erfolgen nach bestem Wissen, befreien den Käufer jedoch nicht von eigenen Prüfungen und Versuchen.

**Warranty**

All information regarding the suitable, workability and applicability of our products, all technical advice and other information are provided to the best of our knowledge and belief, but shall not discharge the buyer from his own examinations and tests.



**Grenzkurve für maximale Pulsenergie bzw. Pulsleistung für Dauerbetrieb  
Maximum puls energy resp. pulse power for continuous operation**

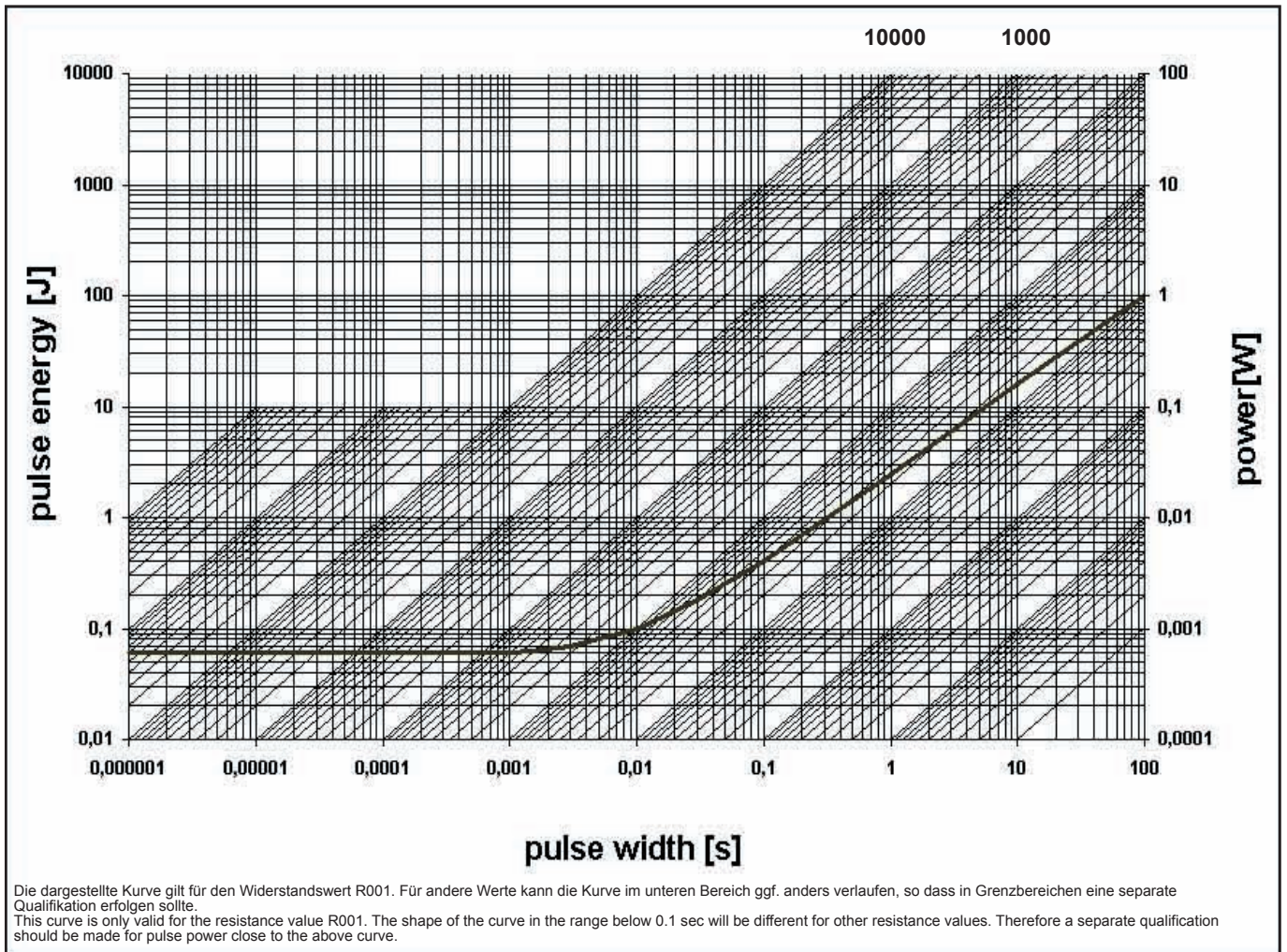

MIL. - STANDARD		
Parameters	Test Conditions	Specification
Maximum Temperature for full power operation	140 °C	140 °C
Working Temperature	-55 to 170 °C	-55 to 170 °C
Thermal Shock	MIL-STD-202 method 107E-B1	0.1 %
Overload	MIL-R-26E (5 times rated power, 5 sec)	0.2 %
Solderability	MIL-STD-202 method 208	> 95 % coverage
Resistance to Solvents	MIL-STD-202 method 215A, 2.1a, 2.1d	no damage
Low Temperature Storage and Operation	MIL-STD-26E	0.1 %
Resistance to Soldering Heat	MIL-STD-202 method 210B	0.1 %
Moisture Resistance	MIL-STD-202 method 106	0.1 %
Shock	MIL-STD-202 method 213B-A	0.2 %
Vibration, High Frequency	MIL-STD-202 method 204D-B	0.2 %
Life	MIL-STD-26E	0.2 %
Storage Life at Elevated Temperature	MIL-STD-202 method 108A-F	0.3 %
Current Noise	MIL-STD-202 method 308	0.01 %
Voltage Coefficient (%/V)	MIL-STD-202 method 309	linearity error less than 120dB
Resistance Temperature Characteristic	MIL-STD-202 method 304 (20-60°C)	< 50 ppm/K
Thermal EMF	0 - 100 °C	2 µV/ °C max.
Frequency Characteristic	inductivity	< 3 nH